

A

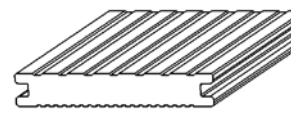
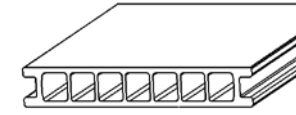
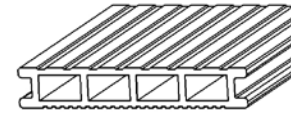

hollow board DFD 162*

hollow board DFDE 162**

full board DFD 140*

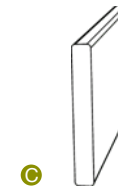
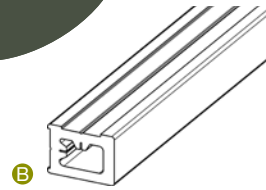

B

C

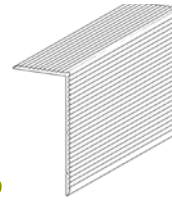
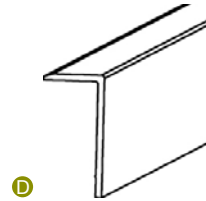

D

E

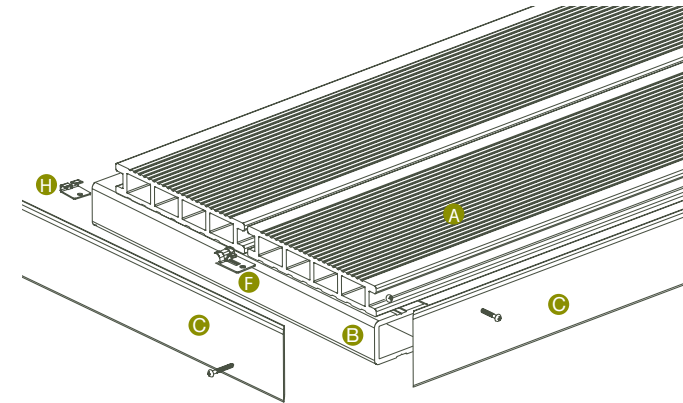

DECKING IN WOOD COMPOSITE

THE PERFECT COMBINATION OF WOOD AND PLASTIC

Duofuse® decking is made out of wood composite. A mix of wood flour and plastic, this means the warmth and look of solid wood combined with the unique properties of plastic.



PART NUMBER

COLOUR

MATERIAL

DIMENSIONS (WXH)

	Graphite Black	Stone Grey	Tropical Brown	Natural Brown		
hollow board DFD 162* A					Wood Flour and PVC	162 x 28 mm
hollow board DFDE 162** A					Wood Flour and PVC	162 x 28 mm
full board DFD 140* A					Wood Flour and PVC	140 x 23 mm
beam DFB048 B					Wood Flour and PVC	48,5 x 35 mm
skirting DFS076 C					Wood Flour and PVC	76 x 10 mm
L profile DFL078 D					Wood Flour and PVC	78 x 39 mm
ALU L profile DFLA076 E					Anodised aluminium	76 x 37 mm
CLIPS						
	DFC001 F standard clip		DFC002 G butting clip		DFC004 H starter and finishing clip	

* double-sided finish: a refined and a robust finish

** double-sided finish: brushed surface and a wood grain finish

Standard length of all boards and profiles : 4 m (other dimensions on request)

10 years for all mechanical properties and resistant against all ant and insect attacks